



www.baylismedical.com

Instructions for Use

VersaCross® RF Wire

English.....1

English

Carefully read all instructions prior to use. Observe all contraindications, warnings and precautions noted in these instructions. Failure to do so may result in patient complications.

Caution: Federal (U.S.A.) law restricts this device to sale by or on the order of a physician.

Baylis Medical Company relies on the physician to determine, assess and communicate to each individual patient all foreseeable risks of the procedure.

I. DEVICE DESCRIPTION

The VersaCross® RF Wire is packaged with a Baylis Single-Use Connector Cable (Connector Cable). The VersaCross® RF Wire must be used with an approved Baylis RFP-100A Radiofrequency Puncture Generator (RF Generator) and the Connector Cable.

The VersaCross® RF Wire delivers radiofrequency (RF) power in a monopolar mode between its distal electrode and a commercially available external Disposable Indifferent (Dispersive) Patch (DIP) Electrode, which is in compliance with current IEC 60601-2-2 requirements. The Connector Cable connects the RF Generator to the VersaCross® RF Wire. This Connector Cable enables RF power to be delivered from the RF Generator to the VersaCross® RF Wire. Detailed information concerning the RF Generator is contained in a separate manual that accompanies the equipment (entitled "Baylis Medical Company Radiofrequency Puncture Generator Instructions for Use").

The dimensions of the VersaCross® RF Wire and the Connector Cable can be found on the device labels. The insulation on the body of the VersaCross® RF Wire facilitates smooth advancement of the device and provides electrical insulation. The floppy distal portion of the VersaCross® RF Wire has a curve and the active tip is rounded to be atraumatic to cardiac tissue unless RF energy is applied. A radiopaque marker coil is positioned on the distal section for visualization under fluoroscopy. The main body of the VersaCross® RF Wire provides a stiff rail for advancing ancillary devices into the left atrium following the creation of an atrial septal defect. The VersaCross® RF Wire features visible markers along its length to assist with aligning the wire tip in a compatible transseptal sheath and dilator assembly (e.g., the VersaCross® Transseptal Sheath kit). The proximal end of the VersaCross® RF Wire is bare metal to connect with the provided Connector Cable. The other end of the Connector Cable connects to the RF Generator.

II. INDICATIONS FOR USE

The VersaCross® RF Wire is indicated for creation of an atrial septal defect in the heart.

III. CONTRAINDICATIONS

The VersaCross® RF Wire is not recommended for use with any conditions that do not require the creation of an atrial septal defect. The Connector Cable is not recommended for use with any other RF Generator or any other device.

IV. WARNINGS

- Only physicians with a thorough understanding of angiography and percutaneous interventional procedures should use this device. It is recommended that physicians avail themselves of pre-clinical training, a review of pertinent literature and other appropriate education before attempting new interventional procedures.
The VersaCross® RF Wire and Connector Cable are supplied STERILE using an ethylene oxide process. Do not use if the package is damaged.
Laboratory staff and patients can undergo significant x-ray exposure during RF puncture procedures due to the continuous usage of fluoroscopic imaging. This exposure can result in acute radiation injury as well as increased risk for somatic and genetic effects. Therefore, adequate measures must be taken to minimize this exposure.
The VersaCross® RF Wire and Connector Cable are intended for single patient use only. Do not attempt to sterilize and reuse either devices. Reuse can cause patient injury and/or the communication of infectious disease(s) from one patient to another. Reuse may result in patient complications.
The VersaCross® RF Wire must be used with the Connector Cable provided. Attempts to use it with other connector cables can result in electrocution of the patient and/or operator.
The Connector Cable must only be used with the RFP-100A RF Generator and the included VersaCross® RF Wire. Attempts to use it with other RF Generators and devices can result in electrocution of the patient and/or operator.
The VersaCross® RF Wire must be used with 0.035" compatible transseptal sheath and dilator devices, such as those in the VersaCross® Transseptal Sheath kit.
The active tip and distal curve of the VersaCross® RF Wire are fragile. Be careful not to damage the tip or the distal curve while handling the VersaCross® RF Wire. If the tip or the distal curve becomes damaged, discard the VersaCross® RF Wire immediately.
If the active tip of the VersaCross® RF Wire becomes bent at any time during its use, discard the VersaCross® RF Wire immediately. Do not attempt to straighten the active tip.
The VersaCross® RF Wire is not intended for use with neonatal patients (i.e. less than one month of age). Do not attempt to treat neonatal patients with the VersaCross® RF Wire.

V. PRECAUTIONS

- Do not attempt to use the VersaCross® RF Wire and the Connector Cable before thoroughly reading the accompanying Instructions for Use.
RF puncture procedures should be performed only by physicians thoroughly trained in the techniques of RF-powered puncture in a fully equipped catheterization laboratory.
The sterile packaging should be visually inspected prior to use. Do not use the devices if the packaging has been damaged or compromised.
Visually inspect the VersaCross® RF Wire and Connector Cable prior to use to ensure there are no cracks or damage to the insulating material. Do not use the wire or the cable if there is any damage.
Do not use the VersaCross® RF Wire and/or Connector Cable after the use-by date indicated on the label.
The VersaCross® RF Wire and Connector Cable are intended for use with only those devices listed in Section VIII, Equipment Required.
Read and follow the manufacturer's Instructions For Use for the DIP electrode. Always use DIP electrodes that meet or exceed IEC 60601-2-2 requirements.
Placement of the DIP electrode on the thigh could be associated with higher impedance.
In order to prevent the risk of ignition, ensure that flammable materials are not present in the room during RF power application.
Take precautions to limit the effects that the electromagnetic interference (EMI) produced by the RF Generator may have on the performance of other equipment. Check the compatibility and safety of combinations of other physiological monitoring and electrical apparatus to be used on the patient in addition to the RF Generator.
Adequate filtering must be used to allow continuous monitoring of the surface electrocardiogram (ECG) during RF power applications.
Do not attempt to insert or retract the VersaCross® RF Wire as the active tip.
Do not attempt to insert or retract the VersaCross® RF wire through a metal cannula or a percutaneous needle.
Do not bend the VersaCross® RF Wire or the Connector Cable. Excessive bending or kinking of the wire shaft, the distal curve of the wire and/ or the Connector Cable may damage the integrity of the

Baylis Medical Company Inc.
5959 Trans-Canada Highway
Montreal, Quebec, Canada, H4T 1A1
Tel: (514) 488-9801/ (800) 850-9801
Fax: (514) 488-7209
www.baylismedical.com



© Copyright Baylis Medical Company Inc., 2008-2020
The Baylis Medical Logo and VersaCross are trademarks and/or registered trademarks of Baylis Medical Company Inc. in the USA and/or other countries. Patents pending and/or issued.

device components and may cause patient injury. Care must be taken when handling the VersaCross® RF Wire and Connector Cable.

- Careful manipulation of the VersaCross® RF Wire must be performed to avoid vessel trauma. If resistance is encountered, DO NOT use excessive force to advance or withdraw the VersaCross® RF Wire or ancillary sheath and dilator assembly.
- VersaCross® RF Wire and ancillary sheath and dilator assembly advancement should be done under imaging guidance. The use of visible markers on the wire body are only an approximate guide for positioning the wire tip with the distal end of the dilator.
- Do not attempt to deliver RF energy until the active tip of the VersaCross® RF Wire is confirmed to be in good contact with the target tissue.
- It is recommended not to exceed five (5) RF power applications per VersaCross® RF Wire.
- Never disconnect the Connector Cable from the RF Generator while RF power is being delivered.
- Never disconnect the Connector Cable from the RF Generator by pulling on the cable. Failure to disconnect the cable properly may result in damage to the cable.
- Do not twist the Connector Cable while inserting or removing it from the Isolated Patient Connector on the RF Generator. Twisting the cable may result in damage to the pin connectors.
- The RF Generator is capable of delivering significant electrical power. Patient or operator injury can result from improper handling of the VersaCross® RF Wire and/or DIP electrode, particularly when operating the device.
- During power delivery, the patient should not be allowed to come in contact with ground metal surfaces.
- Apparent low power output or failure of the equipment to function properly at normal settings may indicate faulty application of the DIP electrode, failure to an electrical lead, or poor tissue contact at the active tip. Check for obvious equipment defects or misapplication. Attempt to better position the active tip of the VersaCross® RF Wire against the atrial septum. Only increase the power if low power output persists.

#### VI. PRODUCT SPECIFICATIONS

Product	VersaCross® RF Wire	Product	RFP 100A Connector Cable
Length	180 or 230cm	Useable Length	10 feet/3m
Wire Diameter	0.035" / 0.89mm	Generator Connector	4-pin (1-pin)
Curve Diameter	9 mm J-tip or 24 mm Pigtail	Device Connector	Push Button

#### VII. ADVERSE EVENTS

Adverse events that may occur while creating an atrial septal defect include:

Tamponade	Sepsis/Infection	Thromboembolic episodes
Vessel perforation	Atrial Fibrillation	Myocardial Infarction
Vessel spasm	Sustained arrhythmias	Atrial Flutter
Hemorrhage	Vascular thrombosis	Perforation of the myocardium
Hematoma	Allergic reaction to contrast medium	Ventricular Tachycardia
Pain and Tenderness	Arteriovenous fistula	Pericardial effusion
Tachycardia		

#### VIII. EQUIPMENT REQUIRED

RF transseptal procedures should be performed in a specialized clinical setting equipped with a fluoroscopy unit, radiographic table, echocardiography imaging, physiologic recorder, emergency equipment and instrumentation for gaining vascular access. Ancillary materials required to perform this procedure include:

- RFP-100A RF Generator
- 0.035" compatible transseptal sheath and dilator devices
- DIP electrode, meeting or exceeding IEC 60601-2-2 requirements for electrosurgical electrodes

#### IX. INSPECTION PRIOR TO USE

Prior to performing the procedure, the VersaCross® RF Wire and the provided Connector Cable should be carefully examined for damage or defects, as should all equipment, including the RF Generator, used in the procedure. Do not use defective equipment. Do not reuse the VersaCross® RF Wire and/or Connector Cable.

#### X. DIRECTIONS FOR USE

- All instructions for equipment required should be carefully read, understood, and followed. Failure to do so may result in complications.
- The VersaCross® RF Wire and Connector Cable are supplied sterile. Use aseptic technique when opening the package and handling the product in the sterile field.
- Connect the generator connector end of the Connector Cable to the isolated patient connector port on the RF Generator as per the RF Generator Instructions for Use. Gently line up the connector pins with the socket and push in until the connector fits firmly into the socket. Any attempt to connect the cable otherwise will damage the pins on the connector.
- Do not use excessive force in connecting the Connector Cable to the RF Generator. Use of excessive force may result in damage to the connector pins.
- Thoroughly flush the transseptal sheath and dilator (not supplied).
- Perform a standard vein puncture at the desired access site using an access needle (not supplied).
- A transseptal sheath and dilator are usually inserted through the access site and are then advanced over a guidewire to be positioned into the Superior Vena Cava (SVC) under fluoroscopic guidance. The VersaCross® RF Wire may be used for this purpose.
- If the VersaCross® RF Wire was not used to advance the sheath to the SVC, remove the guidewire and exchange for the VersaCross® RF Wire with the provided tip straightener.
- Advance the VersaCross® RF Wire through the sheath and dilator assembly until the wire tip is just within the dilator tip. The visible markers on the wire body can be used to assist with the positioning of the wire tip with the distal end of the dilator.
- Firmly grasp the catheter connector end of the Connector Cable in one hand. Using your thumb, depress the red button on the top of the connector. Slowly insert the proximal end of the VersaCross® RF Wire into the opening of the catheter connector. Once the exposed portion of the proximal end of the device is no longer visible, release the red button on the connector. Gently tug on the device to ensure that you have a secure connection.
- Position the wire/sheath/dilator assembly in the right atrium against the fossa ovalis under fluoroscopic guidance using standard technique. Echocardiographic guidance is also recommended.
- Apply pressure to the dilator to tent the septum at the fossa ovalis.
- Advance the VersaCross® RF Wire so that the active tip is engaging the septum at the fossa ovalis but still within the dilator.
- Once appropriate positioning has been achieved, deliver RF power via the RF Generator to the active tip. This results in puncture of the targeted cardiac tissue. Please refer to the RF Generator Instructions for Use for the correct operation of the generator.
- Apply firm pressure to the VersaCross® RF Wire during the application of RF energy to successfully advance the VersaCross® RF Wire through the tissue.
- NOTE: Use the lowest appropriate RF settings to achieve the desired puncture.**

- For RFP-100A: An initial RF setting between one (1) second on "PULSE" mode to two (2) seconds on "CONSTANT" mode has been shown to be sufficient for successful puncture.
- RF power delivery can be terminated by pressing the RF ON/OFF button on the RF Generator if the timer has not expired.
- Entry into the left atrium can be confirmed by monitoring the VersaCross® RF Wire under fluoroscopy. Echocardiographic guidance is also recommended.
- If septal puncture is not successful after five (5) RF power applications, it is advised that the user utilize an alternate method for the procedure.
- Once the puncture is successfully completed, the VersaCross® RF Wire should be mechanically advanced without any RF power. Positioning in the left atrium is sufficient when the full distal curve and floppy section have crossed the septum and are observed under fluoroscopy in the left atrium. Echocardiographic guidance is also recommended.
- The dilator can then be advanced over the VersaCross® RF Wire to enlarge the puncture.
- To disconnect the VersaCross® RF Wire from the Connector Cable, depress the red button on the catheter connector and gently remove the proximal end of the VersaCross® RF Wire from the Connector Cable.
- To disconnect the Connector Cable from the RF Generator, grasp the connector firmly and gently pull it straight out of the socket.
- Retract the VersaCross® RF Wire slowly through the transseptal sheath and dilator assembly.

#### Connections

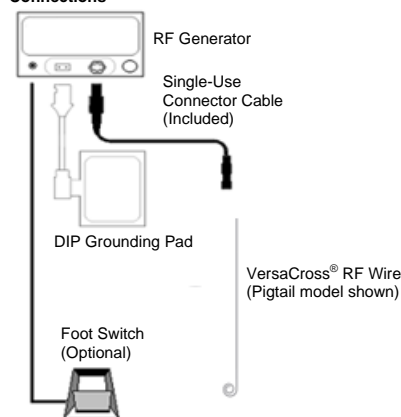

#### XI. CLEANING AND STERILIZATION INSTRUCTIONS

The VersaCross® RF Wire and Connector Cable are intended for single use only. Do not clean or sterilize the VersaCross® RF Wire and/or Connector Cable.

#### XII. TROUBLESHOOTING

The following table is provided to assist the user in diagnosing potential problems.

PROBLEM	COMMENTS	TROUBLESHOOTING
Connector Cable does not fit into the Isolated Patient Connector on the front panel of the generator	The connectors are designed to connect in a specific way for safety reasons. If the connector "keys" are out of line, the connectors won't fit together.	Check that the connector keys are lined up in the proper orientation.
Generator Error Messages	In order to successfully perforate tissue using RF energy, all devices must be properly connected and in good working order.	Ensure that all connections are made i.e.: - VersaCross® RF Wire to Connector Cable - Connector Cable to RF Generator - RF Generator to power outlet - RF Generator to grounding pad  Visually inspect the VersaCross® RF Wire and Connector Cable for damage. Immediately discard any damaged devices. If problem persists, discontinue use.  For error messages encountered while attempting RF puncture, refer to the Instructions for Use that accompanies the RF Generator.
Wire breaks or kinks	Breaks and kinks in the VersaCross® RF Wire are a potential cause of patient injury.	Discard immediately.















#### XIII. CUSTOMER SERVICE AND PRODUCT RETURN INFORMATION

If you have any problems with or questions about Baylis Medical Equipment, contact our technical support personnel.

#### NOTES:

- In order to return products, you must have a return authorization number before shipping the products back to Baylis Medical Company. Product Return Instructions will be provided to you at this time.
- Ensure that any product being returned to Baylis Medical has been cleaned, decontaminated and/or sterilized as indicated in the Product Return Instruction before returning it for warranted service. Baylis Medical will not accept any piece of used equipment that has not been properly cleaned or decontaminated as per the Product Return Instructions.

**XIV. LABELING AND SYMBOLS**

	Keep Dry		Use-By Date
	Manufacturer		Do Not Use if Package is Damaged
	Lot Number		Caution
	Model Number		Keep Away from Sunlight
	Do Not Resterilize		Non-Pyrogenic
	Do Not Reuse		Follow Instructions for Use
	Sterile using ethylene oxide		<b>Caution:</b> Federal (U.S.A.) law restricts this device to sale by or on the order of a physician.

**XV. LIMITED WARRANTY – DISPOSABLES AND ACCESSORIES**

Baylis Medical Company Inc. (BMC) warrants its Disposable and Accessory products against defects in materials and workmanship. BMC warrants that sterile products will remain sterile for a period of time as shown on the label, as long as the original package remains intact. Under this Limited Warranty, if any covered product is proved to be defective in materials or workmanship, BMC will replace or repair, in its absolute and sole discretion, any such product, less any charges to BMC for transportation and labor costs incidental to inspection, removal or restocking of product. The length of the warranty is: (i) for the Disposable products, the shelf life of the product, and (ii) for the Accessory products, 90 days from shipment date.

This limited warranty applies only to new original factory delivered products that have been used for their normal and intended uses. BMC's Limited Warranty shall not apply to BMC products which have been resterilized, repaired, altered, or modified in any way and shall not apply to BMC products which have been improperly stored or improperly cleaned, installed, operated or maintained contrary to BMC's instructions.

**DISCLAIMER AND LIMITATION OF LIABILITY**

THE LIMITED WARRANTY ABOVE IS THE SOLE WARRANTY PROVIDED BY SELLER. SELLER DISCLAIMS ALL OTHER WARRANTIES, WHETHER EXPRESS OR IMPLIED, INCLUDING ANY WARRANTY OF MERCHANTABILITY OR FITNESS FOR A PARTICULAR USE OR PURPOSE.

THE REMEDY SET FORTH HEREIN SHALL BE THE EXCLUSIVE REMEDY FOR ANY WARRANTY CLAIM, AND ADDITIONAL DAMAGES, INCLUDING CONSEQUENTIAL DAMAGES OR DAMAGES FOR BUSINESS INTERRUPTION OR LOSS OF PROFIT, REVENUE, MATERIALS, ANTICIPATED SAVINGS, DATA, CONTRACT, GOODWILL OR THE LIKE (WHETHER DIRECT OR INDIRECT IN NATURE) OR FOR ANY OTHER FORM OF INCIDENTAL, OR INDIRECT DAMAGES OF ANY KIND, SHALL NOT BE AVAILABLE. SELLER'S MAXIMUM CUMULATIVE LIABILITY RELATIVE TO ALL OTHER CLAIMS AND LIABILITIES, INCLUDING OBLIGATIONS UNDER ANY INDEMNITY, WHETHER OR NOT INSURED, WILL NOT EXCEED THE COST OF THE PRODUCT(S) GIVING RISE TO THE CLAIM OR LIABILITY. SELLER DISCLAIMS ALL LIABILITY RELATIVE TO GRATUITOUS INFORMATION OR ASSISTANCE PROVIDED BY, BUT NOT REQUIRED OF SELLER HEREUNDER. ANY ACTION AGAINST SELLER MUST BE BROUGHT WITHIN EIGHTEEN (18) MONTHS AFTER THE CAUSE OF ACTION ACCRUES. THESE DISCLAIMERS AND LIMITATIONS OF LIABILITY WILL APPLY REGARDLESS OF ANY OTHER CONTRARY PROVISION HEREOF AND REGARDLESS OF THE FORM OF ACTION, WHETHER IN CONTRACT, TORT (INCLUDING NEGLIGENCE AND STRICT LIABILITY) OR OTHERWISE, AND FURTHER WILL EXTEND TO THE BENEFIT OF SELLER'S VENDORS, APPOINTED DISTRIBUTORS AND OTHER AUTHORIZED RESELLERS AS THIRD-PARTY BENEFICIARIES. EACH PROVISION HEREOF WHICH PROVIDES FOR A LIMITATION OF LIABILITY, DISCLAIMER OF WARRANTY OR CONDITION OR EXCLUSION OF DAMAGES IS SEVERABLE AND INDEPENDENT OF ANY OTHER PROVISION AND IS TO BE ENFORCED AS SUCH.

IN ANY CLAIM OR LAWSUIT FOR DAMAGES ARISING FROM ALLEGED BREACH OF WARRANTY, BREACH OF CONTRACT, NEGLIGENCE, PRODUCT LIABILITY OR ANY OTHER LEGAL OR EQUITABLE THEORY, THE BUYER SPECIFICALLY AGREES THAT BMC SHALL NOT BE LIABLE FOR DAMAGES OR FOR LOSS OF PROFITS, WHETHER FROM BUYER OR BUYER'S CUSTOMERS. BMC'S LIABILITY SHALL BE LIMITED TO THE PURCHASE COST TO BUYER OF THE SPECIFIED GOODS SOLD BY BMC TO BUYER WHICH GIVE RISE TO THE CLAIM FOR LIABILITY.

No agent, employee or representative of Baylis Medical has the authority to bind the Company to any other warranty, affirmation or representation concerning the product.

This warranty is valid only to the original purchaser of Baylis Medical products directly from a Baylis Medical authorized agent. The original purchaser cannot transfer the warranty.

Use of any BMC product shall be deemed acceptance of the terms and conditions herein.

The warranty periods for Baylis Medical products are as follows:

Disposable Products	The shelf life of the product
Accessory Products	90 days from the shipment date